

Investigation of Transient Stability for Variable Speed Wind Turbine driving a Permanent Magnet Synchronous Generator

G.Kala Priyadarshini¹, K.Presilla Vasanthini², S.Hemalatha³

Assistant Professor, Department of Electrical and Electronics Engineering, Prince Shrivenkateswara Padmavathi
Engineering College, Chennai, India^{1,2,3}

ABSTRACT-This paper presents a new operational strategy for a small scale wind farm is adopted. A variable speed wind turbine generator systems (WTGS) driving a Permanent Magnet Synchronous Generator is used. Fixed speed wind generators suffer greatly from meeting the requirements of new wind farm grid code, because they are largely dependent on reactive power. Integration of flexible ac transmission systems (FACTS) devices is a solution to overcome this problem, though it definitely increases the overall cost. This paper focuses on the transient stability analysis of variable speed wind turbine driving a PMSG, where the stability during symmetrical and unsymmetrical faults is analyzed.

KEYWORDS:-Permanent magnet synchronous generator(PMSG), multilevel converter/inverter, transient stability, variable speed wind generator.

I. INTRODUCTION

As a result of increasing environmental concern, the impact of conventional electricity generation on the environment is being minimized and efforts are made to generate electricity from renewable sources. The main advantages of electricity generation from renewable sources are the absence of harmful emissions and the infinite availability of the wind energy that is converted into electricity. One way of generating electricity from renewable sources is to use wind turbines that convert the energy contained in flowing air into electricity. Transient stability analysis for fixed speed wind generators has been reported in many literatures [3-5]. But variable speed WTGS has recently become more popular than the fixed speed WTGS. In 2004, the world-wide market share of variable speed WTGS was more than 60% [6]. Doubly fed induction generator (DFIG), wound field synchronous generator, and permanent magnet synchronous generator (PMSG) are currently used as variable speed wind generators. Stability analysis of DFIG type of VSWT is already reported in many literatures [7-9]. In [10], the transient stability analysis of VSWT using field excited synchronous generator has been presented, where only unsymmetrical fault is considered as a network disturbance.

In PMSG, the excitation is provided by permanent magnets instead of field winding. Permanent magnet machines are characterized as having large air gaps which reduce flux linkage even in machines with multi magnetic poles [11-12]. As a result, low rotational speed generators can be manufactured with relatively small sizes with respect to its power rating. Moreover, gearbox can be omitted due to low rotational speed in PMSG wind generators, resulting in low cost. In [13-15], detailed modelling and control system of variable speed PMSG wind generator systems are presented. Simulation analyses have been performed by using MATLAB, in which the PMSG, electrical network, both converter/inverter, and their controllers are implemented by using its standard library models.

Different types of symmetrical and unsymmetrical faults are considered to be occurred at several locations in the model system. It is found that by controlling the power converters of PMSG in proper way, the transient stability of VSWT-PMSG can be enhanced.

International Journal of Innovative Research in Science, Engineering and Technology

(A High Impact Factor & UGC Approved Journal)

Website: www.ijirset.com

Vol. 6, Issue 9, September 2017

II. WIND TURBINE MODELING

The mathematical relation for the mechanical power extraction from the wind can be expressed as follows [16]:

The mathematical relation for the mechanical power extraction from the wind can be expressed as follows [16]: Where, P_w is extracted power from the wind, ρ is the air density [kg/m³], R is blade radius [m], V_w is the wind speed [m/s] and C_p is the power coefficient which is a function of both tip speed ratio, λ and blade pitch angle, β [deg]. To Calculate C_p for the given values of β and λ the following numerical approximations have been used) ,

The power is directly proportional to the cubic velocity of wind. The kinetic energy of the wind is converted into energy

$$P \propto \frac{1}{2} m v^2 \quad (\text{Since } m = \rho v A)$$

$$P \propto \frac{1}{2} \rho A v^3 \quad (A = \text{swept area})$$

$$P = \frac{1}{2} C_p \rho A v^3$$

Where, P_w is extracted power from the wind, ρ is the air density [kg/m³], R is blade radius [m], V_w is the wind speed [m/s] and C_p is the power coefficient which is a function of both tip speed ratio, λ and blade pitch angle, β [deg]. To Calculate C_p for the given values of β and λ the following numerical approximations have been used.

$$\lambda = \frac{\omega_r R}{V_w}$$

$$\lambda_t = \frac{1}{\frac{1}{\lambda + 0.02\beta} - \frac{0.003}{\beta^3 + 1}}$$

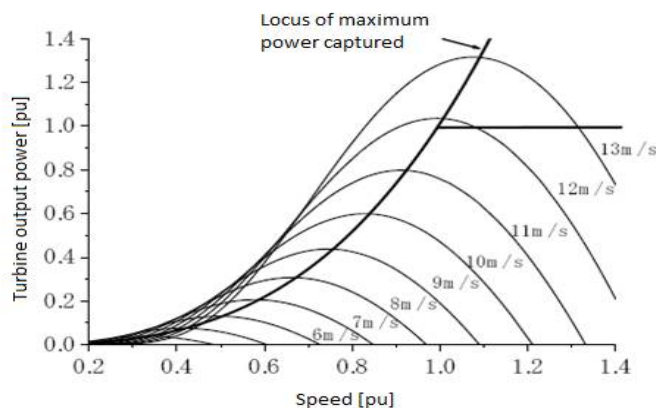

Fig. 1. Turbine characteristic with maximum power point tracking

For VSWT, generated power from the turbine depends on the power coefficient C_p . For the wind speed of VSWT, there is a specific turbine rotational speed which generates the maximum power. In this way, the maximum power point tracking (MPPT) for each wind speed increases the energy generation in VSWT. The power coefficient curve with the MPPT curve is shown in Fig.1, from which it can be seen that, for any particular wind speed, there is a rotational speed ω_r , which generates the maximum power P_{max} , called also as the optimum power P_{opt} . When the wind speed changes,

International Journal of Innovative Research in Science, Engineering and Technology

(A High Impact Factor & UGC Approved Journal)

Website: www.ijirset.com

Vol. 6, Issue 9, September 2017

the rotational speed is controlled to follow the maximum power point trajectory. It should be noted here that the measurement of the precise wind speed is not so easy. Therefore, it is better to calculate the optimum power P_{opt} , without measuring wind speed as shown below

$$P_{opt} = P_{max} = 0.5 \rho \pi R^2 \left(\frac{\omega_r R}{\lambda_{opt}} \right)^3 C_{p-opt}$$

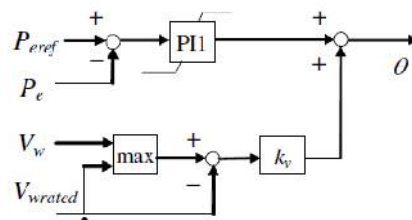

Fig .2. Pitch controller

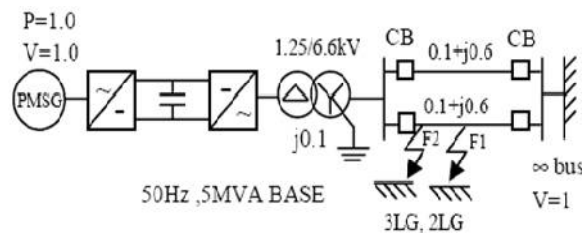

Fig.3. Model system

The model system used for the transient stability analysis of VSWG- PMSG is shown in Fig.3. Here one PMSG is connected to the infinite bus through a generator-side converter, dc-link capacitor, grid-side inverter, 1.25/6.6kV transformer, and double circuit transmission line. To analyze the stability of the system a fault is applied at points F1 and F2. Fault may be symmetrical or unsymmetrical faults.

Generator parameters are given in table1

Rated Power	5[MW]	Stator Resistance	0.01[pu]
Rated voltage	1.0[kV]	d-axis reactance	1.0[pu]
Frequency	20[Hz]	q-axis reactance	0.7[pu]
Number of poles	150	Field Flux	1.4[pu]
Inertia constant(H)	3.0[sec]	-	-

Table1: Generator Parameters

International Journal of Innovative Research in Science, Engineering and Technology

(A High Impact Factor & UGC Approved Journal)

Website: www.ijirset.com

Vol. 6, Issue 9, September 2017

III. MODELING OF PWM FREQUENCY CONVERTER

The electrical scheme of VSWT-PMSG topology is shown in Fig. 4. The PMSG model available in the package software MATLAB is used.

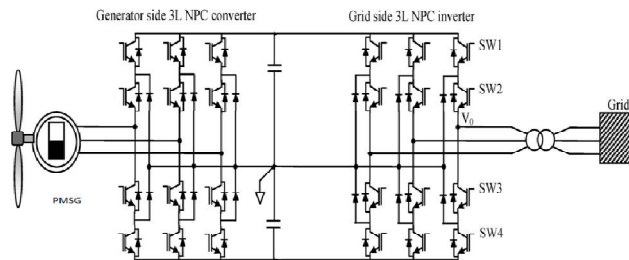

Fig.4. Electrical scheme of VSWT-PMSG.

The pulse width modulation (PWM) frequency converter consists of generator side ac/dc converter, dc-link capacitor, and grid side dc/ac inverter. Three-level (3L) neutral point clamped (NPC) topology is considered for both converter and inverter as shown in Fig. 4. The three-level converter has the advantages that the blocking voltage of each switching device is one half of dc-link voltage in contrast to the full dc-link voltage in case of the two-level converter, and the harmonic contents of three-level converter output voltage are much less than those of two-level one, at the same switching frequency. The control strategies of the 3L-NPC converter and inverter are demonstrated below. A. Grid Side Multilevel Inverter

Control blocks for the grid-side inverter are shown in Fig. 5. The dq quantities and three-phase electrical quantities are related to each other by reference frame transformation. The angle of the transformation is detected from the three phase voltages (v_a, v_b, v_c) at the high voltage side of the grid side transformer. The dc voltage of the dc-link capacitor is controlled constant by two PI controllers. The d-axis current can control the dc-link voltage. On the other hand, the q-axis current can control the reactive power of grid-side inverter. The reactive power reference is set in such a way that the terminal voltage at high voltage side of the transformer remains constant. Therefore, total three PI controllers are used to control the reactive power of grid-side inverter. The additional PI controller provides excellent transient characteristic during network disturbance as shown later. The carrier frequency of both converters is chosen 1050hz. The dc-link capacitor value is chosen 30000 μ F. The rated dc-link voltage is 2kV.

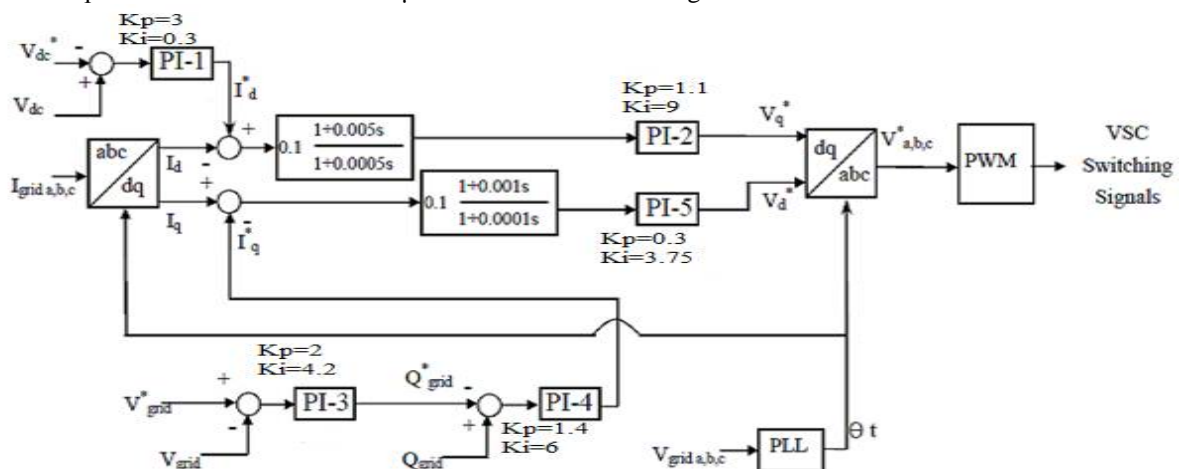

Fig. 6. Control block for the generator side converter

IV. SIMULATION RESULTS

Pitch controller output is shown in fig7 In this the pitch controller is actuated when the output power becomes greater than rated power of PMSG. In this pitch controller is used for simple system and wind speed is assumed to be greater than rated wind speed, the rated speed is assumed as 12m/s. Pitch angle varies to control the rotational speed of PMSG. A symmetrical three line to ground fault, 3LG and unsymmetrical double line to ground fault (phase B, C and ground) are considered as network disturbance, which occur at different point of transmission line. The fault occurs at 0.04sec. The circuit breakers on faulted line are opened at .1sec and at .4sec circuit breakers are re-closed. For detailed transient stability analysis three cases are considered Case1: In this case, a 3LG fault is considered on the transmission line. Output voltage and current of PMSG is shown in fig 8. PMSG rotor speed is shown in fig.9

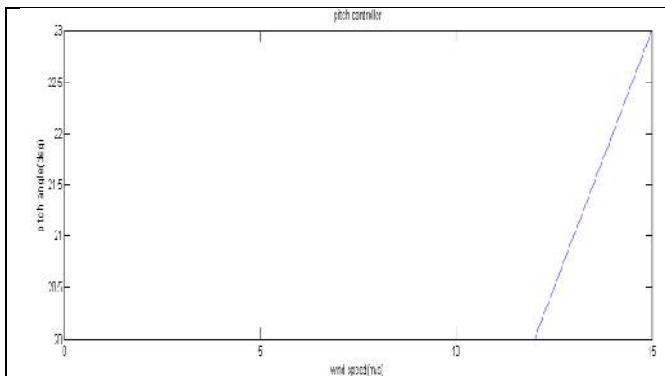

Fig .7. Pitch angle vs wind speed characteristics of PMSG

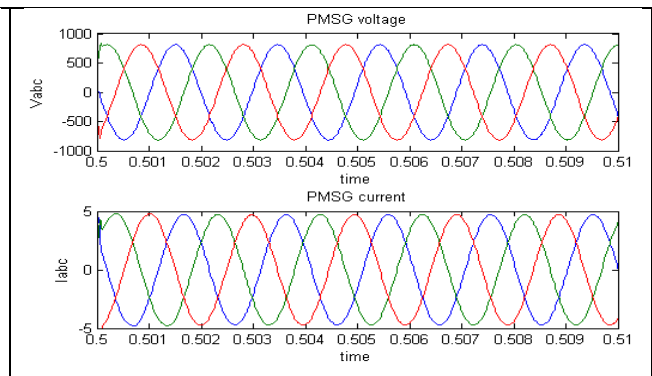

Fig .8. Voltage and current of PMSG

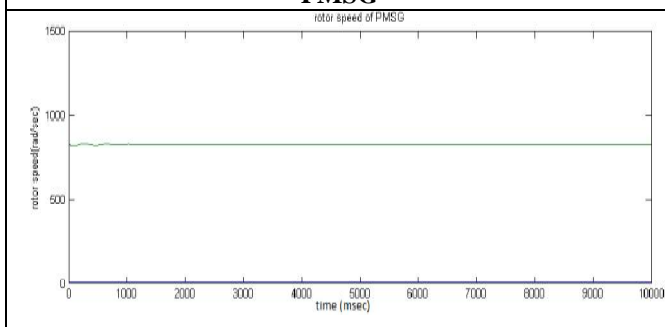

Fig.9. Rotor speed of PMSG

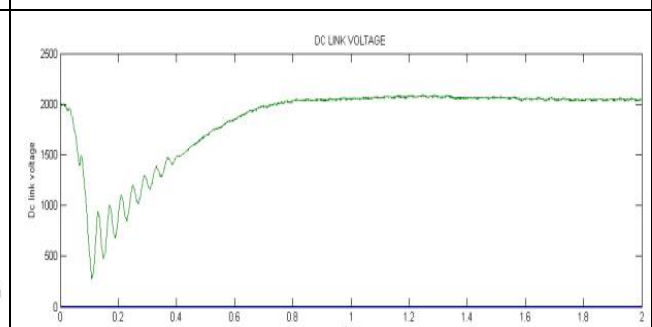

Fig.10. dc link voltage (case1)

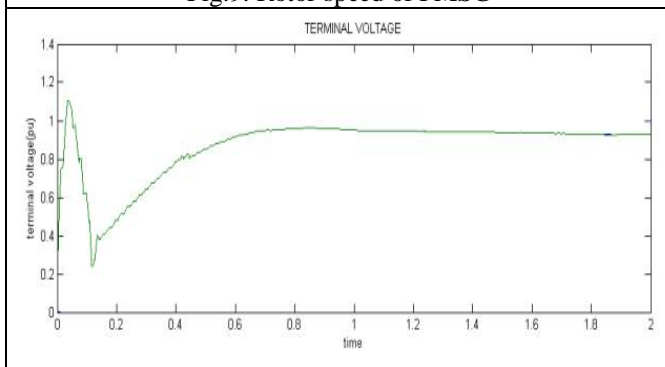

Fig.11. terminal voltage (case1)

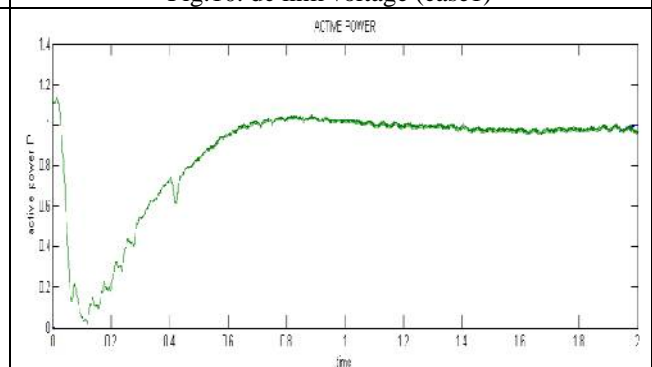

Fig.12. grid side converter active power (case1)

International Journal of Innovative Research in Science, Engineering and Technology

(A High Impact Factor & UGC Approved Journal)

Website: www.ijirset.com

Vol. 6, Issue 9, September 2017

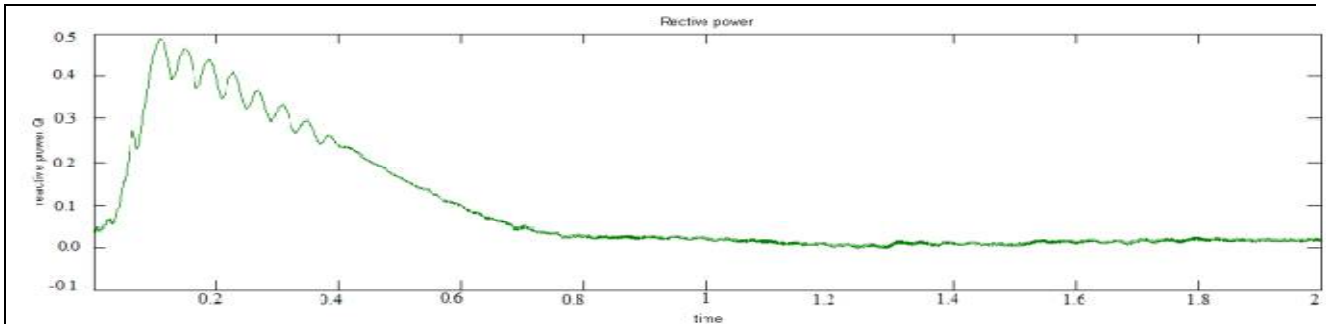

Fig. 13. grid side converter reactive power (case1) Case 2:

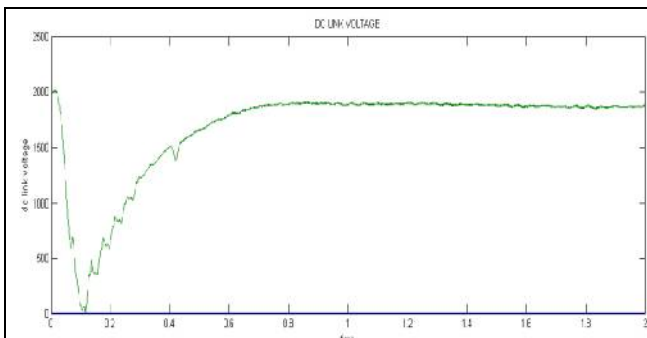

Fig. 14. dc link voltage (case2)

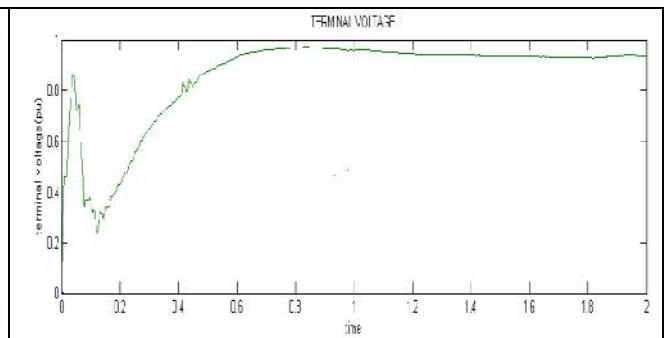

Fig. 15. terminal voltage (case2)

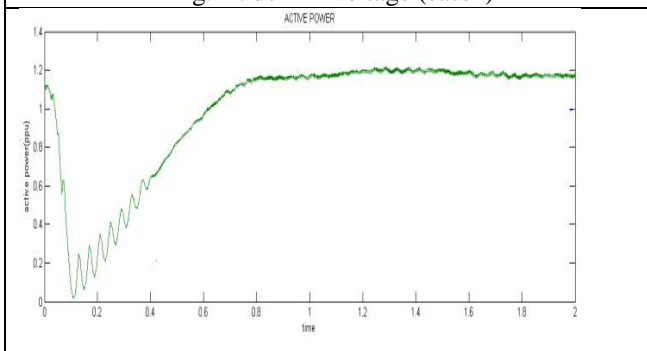

Fig. 16. grid side converter active power case2

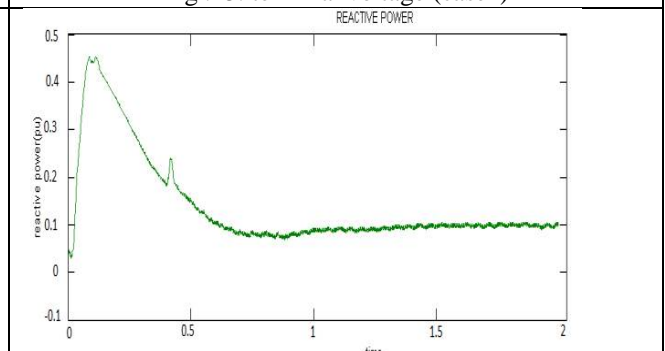

Fig. 17. grid side converter reactive power (case2)

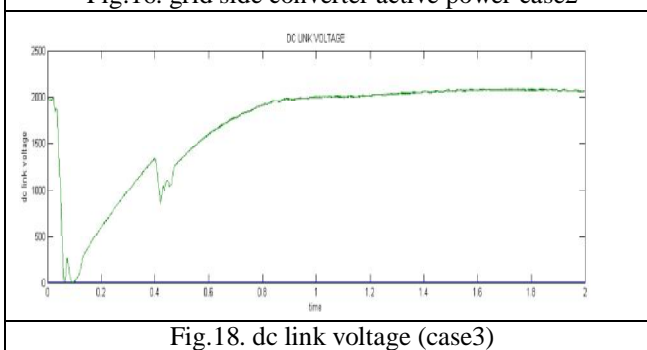

Fig. 18. dc link voltage (case3)

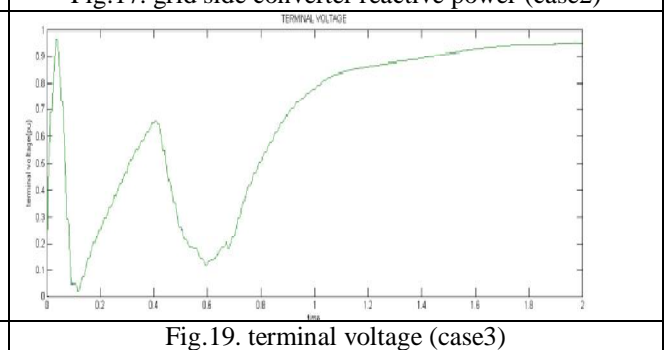

Fig. 19. terminal voltage (case3)

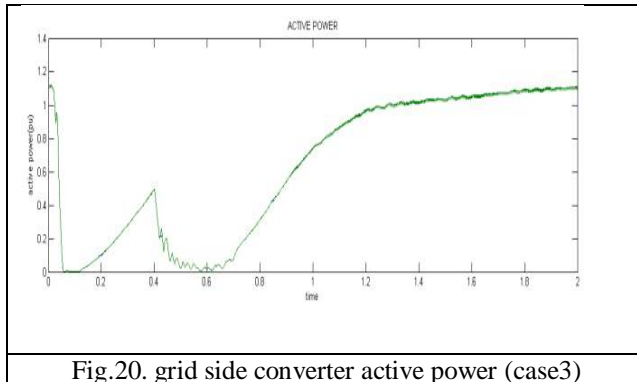

Fig.20. grid side converter active power (case3)

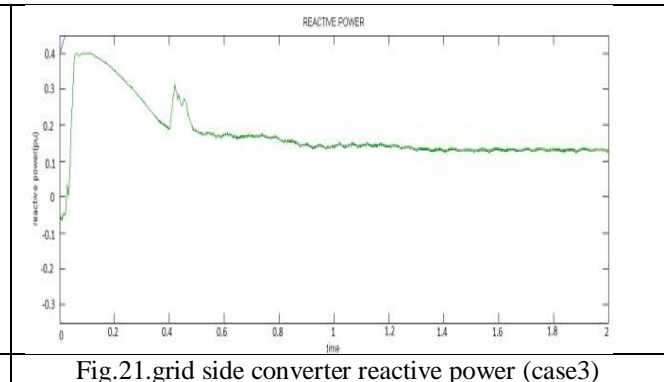

Fig.21.grid side converter reactive power (case3)

The grid side inverter can provide necessary reactive power during the network disturbance as shown in fig.13. Therefore, the terminal voltage can return back at its pre-fault level as shown in fig.11. The response of dc-link voltage is shown in fig.10. From the simulation result it is seen that proposed control system can enhance transient stability of VSWT-PMSG, when a 3LG fault occurs. In this case, an unsymmetrical 2LG fault is considered to occur at the sending end of transmission line. The response of dc-link voltage, terminal voltage of grid side inverter active power and reactive power are shown in fig 14,15,16,17 respectively.

From these results, it is seen that proposed scheme can enhance stability. Case3: In this an unsymmetrical 2LG fault is considered to occur at sending end of transmission line. Response of dc-link voltage, terminal voltage of grid, grid side inverter active power, and reactive power are shown in fig 18,19,20,21 respectively. In this case also the proposed scheme can enhance transient stability of VSWT-PMSG.

V. CONCLUSIONS

Transient stability of variable speed wind turbine driving a PMSG is analyzed when a network disturbance occurs in the power system. The modelling and control strategy of generator and power converters are presented. The proposed control strategy can provide maximum power to grid and can also control reactive power to maintain the terminal voltage of grid constant. Both symmetrical and unsymmetrical fault are considered as network disturbances. The proposed control system can increase the low voltage ride through (LVRT) capability of VSWT-PMSG and thus wind generator shutdown phenomenon can be decreased during the network disturbances.

REFERENCES

- [1] S.M.Muyeen, Rion Takahashi, Toshiaki Murata and Junji Tamura, —A Variable Speed Wind turbine Control Strategy to Meet Wind Farm Grid Code Requirements, IEEE trans on power system, vol.25,no.1, February 2010.
- [2] S. M. Muyeen, R. Takahashi, T. Murata, J. Tamura, and M. H. Ali, —Transient stability analysis of permanent magnet variable speed synchronous wind generator, in Proc. Int. Conf. Electrical Machines and Systems 2007 (ICEMS 2007), Seoul, Korea, Oct. 2007, pp. 288–293.
- [3] E.S.Abdin et al., —Control Design and Dynamic Performance Analysis of a Wind Turbine Induction Generator Unit, IEEE Trans. on Energy Conversion, Vol.EC-15, No.1, p.91, 2000.
- [4] S. M. Muyeen, Mohd. Hasan Ali, Rion Takahashi, Toshiaki Murata, and Junji Tamura, —Transient Stability Enhancement of Wind Generator by a New Logical Pitch Controller, IEEE Trans. PE., Vol.126-B, No.08, pp.742-752, 2006.
- [5] S.M.Muyeen, Mohd. Hasan Ali, Rion Takahashi, Toshiaki Murata, Junji Tamura, Yuichi Tomaki, A. Sakahara, and Eiichi Sasano, —Transient Stability Analysis of Grid Connected Wind Turbine Generator System Considering Multi-Mass Shaft Modeling, Electric Power Components & Systems, Vol.34, No.10, pp.1121-1138, 2006.
- [6] F. V. hulle, —Large Scale Integration of Wind Energy in the European Power Supply Analysis, Issue and Recommendations, EWEA, Tech. Rep., December 2005.
- [7] P. Ledesma and J. Usaola, —Doubly fed induction generator model for transient stability analysis, IEEE Trans. on Energy Conversion, Vol.20, No.2, pp.388-397, 2005.
- [8] P. La Seta and P. Schegner, —Comparison of stabilizing methods for doubly-fed induction generators for wind turbines, International Conference on Future Power System, Conference CDROM, 2005.

International Journal of Innovative Research in Science, Engineering and Technology

(A High Impact Factor & UGC Approved Journal)

Website: www.ijirset.com

Vol. 6, Issue 9, September 2017

- [9] T. Sun, Z. Chen, and F. Blaabjerg, —Transient stability of DFIG wind turbines at an external short-circuit fault,| *Wind Energy*, Vol.8, No.3, pp.345-360, 2005.
- [10] Jan svensson, —Grid-connected voltage source converter-control principles and wind energy applications| submitted to school of electrical and computer engineering chalmers University of Technology.
- [11] AmirnaserYazdani and Reza Iravani, —A Neutral-Point Clamped Converter System for Direct-Drive Variable-Speed Wind Power Unitl, *IEEE transactions on energy conversion*, vol. 21, no. 2, june 2006
- [12] C. L. Souza et al., —Power system transient stability analysis including synchronous and induction generator,| in *Proc. IEEE Porto Power Tech*, 2001, vol. 2, p. 6.
- [13] R. Zavadil, N. Miller, A. Ellis, and E. Muljadi, —Making connections,| *IEEE Power Energy Mag.*, vol. 3, no. 6, pp. 26–37, 2005
- [14] L. Gyugyi, —Unified power-flow control concept for flexible ac transmission systems,| *Proc. Inst. Elect. Eng. C*, vol. 139, no. 4, pp. 323–331, 1992.
- [15] L. Gyugyi, —Dynamic compensation of AC transmission lines by solid state synchronous voltage sources,| *IEEE Trans. Power Del.*, vol. 9, no. 2, pp. 904–911, Apr. 1994.
- [16] H. F. Wang, F. Li, and R. G. Cameron, —Facts control design based on power system nonparametric models,| *Proc. Inst. Elect. Eng., Gen., TransmDistrib.*, vol. 146, no. 5, pp. 409–415, 1999.
- [17] L. Zhang, C. Shen, M. L. Crow, L. Dong, S. Pekarek, and S. Atcitty, —Performance indices for the dynamic performance of FACTS and FACTS with energy storage,| *Elect. Power compon. Syst.*, vol. 33, no. 3, pp. 299–314, Mar. 2005.
- [18] S. M. Muyeen, M. A. Mannan, M. H. Ali, R. Takahashi, T. Murata, and J. Tamura, —Stabilization of wind turbine generator system by STATCOM,| *IEEJ Trans. PE*, vol. 126-B, no. 10, pp. 1073–1082, 2006.
- [19] M. H. Ali, T. Murata, and J. Tamura, —Minimization of fluctuations of line power and terminal voltage of wind generator by fuzzy logic controlled SMES,| *Int. Rev. Elect. Eng. (I.R.E.E.)*, vol. 1, no. 4, pp. 559–566, Oct. 2006.